

viewmate ^x

5

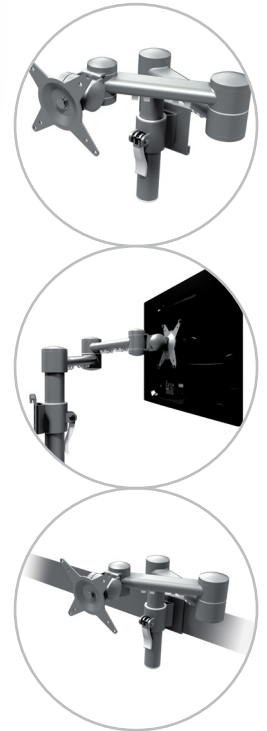
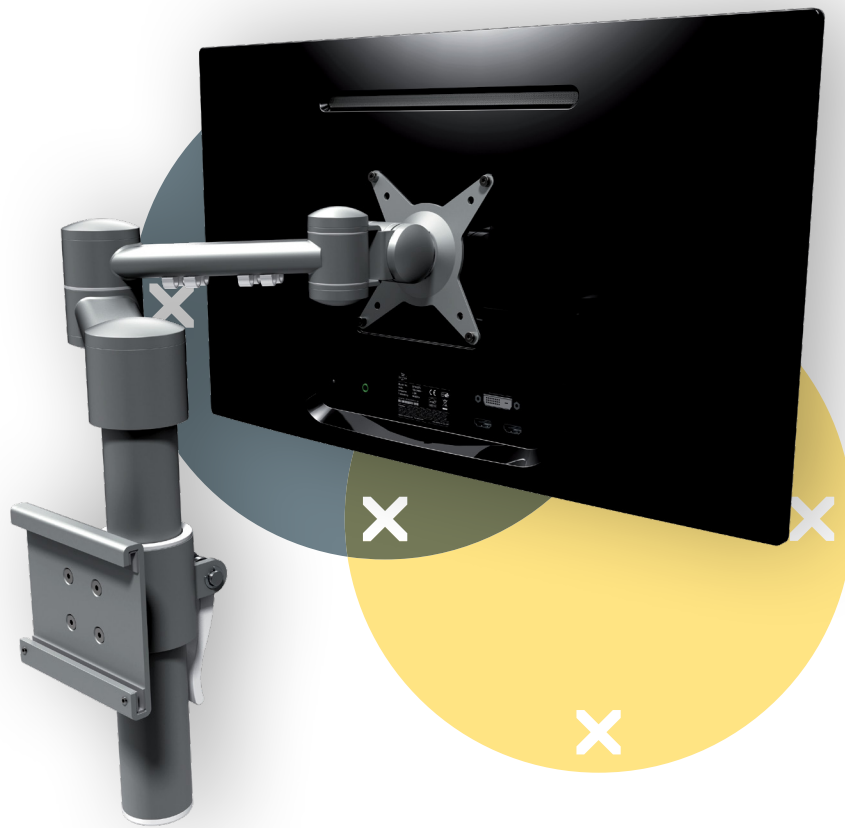

52.152

Viewmate monitor arm - rail 152

Besides having the solid construction Viewmate is known for, this toolbar mount offers toolless depth and height adjustment. The clamp lever lets you adjust and set the height of a monitor, which is essential for aligning monitors of different size and weight. Its horizontal glide ensures easy placement anywhere along the toolbar.

- Static height adjustment range of 155 mm
- Depth adjustment
- Fitted with cable clips to guide cables tidily
- Main components made of steel
- VESA MIS-D 75 x 75/100 x 100 mm compatible
- Rotate 360°, tilt +90°/-90°, swivel 360°
- Weight capacity max. 15 kg per monitor
- Mount exclusively compatible with Viewmate toolbars
- Simply slides onto the toolbar rail
- Easy to adjust in height using a clamp lever

dataflex^x

feeling at work

viewmate ^x

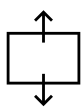
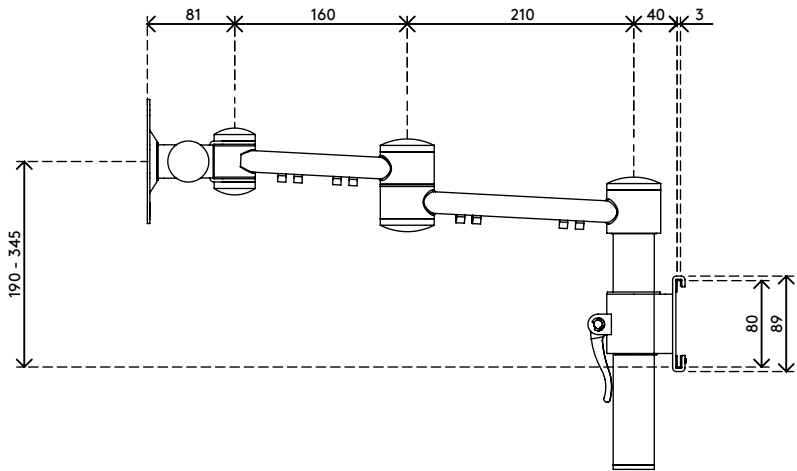
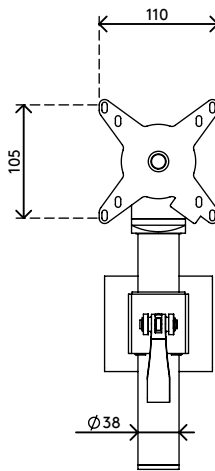
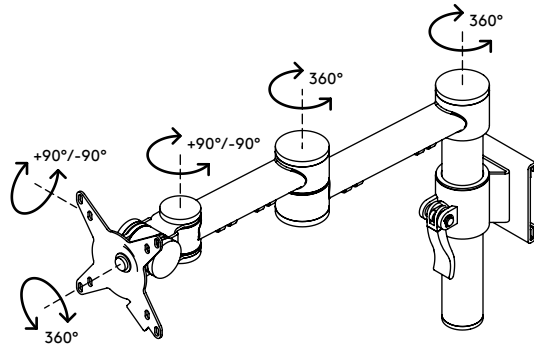
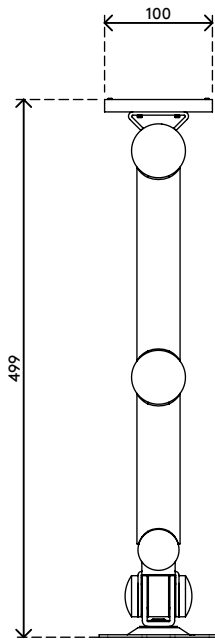

155 mm (6,1")



+90°/-90°



+90°/-90°



360°



75 x 75/100 x 100



15 kg

Viewmate monitor arm - rail 152

2015/10/05

52.152

350 x 300 x 125 mm

1 pcs

silver

3,3 kg

805410521523