



53.133

Viewmaster multi-monitor system - desk 133

The simplest set-up for a single flat screen monitor. This is an ideal, compact POS (Point Of Sale) solution. The ball joint in the monitor mount lets you adjust the monitor any way you like.

- Viewmaster multi-monitor system - desk 133
- Stepless height adjustment
- For 1 monitor
- Die-cast aluminium parts
- VESA MIS-D 75 x 75/100 x 100 mm compatible
- Rotate 360°, tilt +55°/-55°, pivot +90°/-90°
- Weight capacity max. 12 kg per monitor
- Desk mount not included
- Monitor size limit: height 618 mm
- Due to excellent stability also suitable for touchscreens

viewmaster

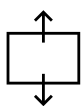
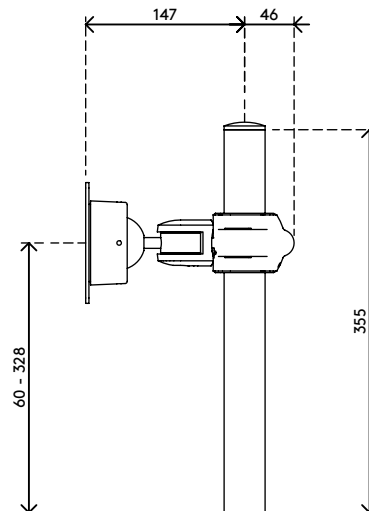
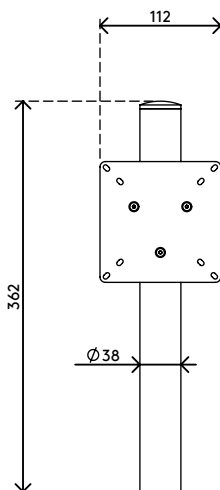
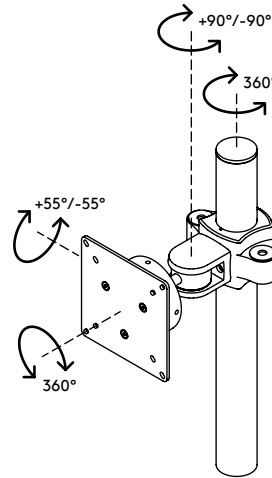
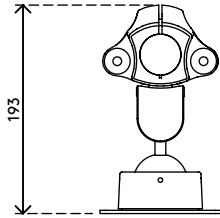

268 mm (10,6")



+55°/-55°

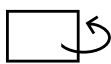

+90°/-90°



360°



618 mm (24,3")



75 x 75/100 x 100



12 kg

Viewmaster multi-monitor system - desk 133

2015/10/05

53.133

 445 x 180 x 145 mm

 1 pcs

 black

 1,79 kg

 805410531331