

53.443

Viewmaster multi-monitor system - desk 443

This model mounts 4 monitors in a row. Like on all other winged multi-monitor systems, each monitor can be adjusted individually. Cable management in the wings tidies up all cables, resulting in an impressive, curved set-up.

- Stepless height adjustment
- For 4 monitors
- Cable clips and loop ties included
- Die-cast aluminium parts
- VESA MIS-D 75 x 75/100 x 100 mm compatible
- Rotate 360°, tilt +55°/-55°, pivot +90°/-90°
- Weight capacity max. 12 kg per monitor
- Desk mounts not included
- Monitor size limit: width 610 - height 618 mm
- Due to excellent stability also suitable for touchscreens

viewmaster x

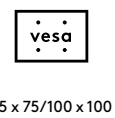
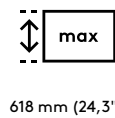
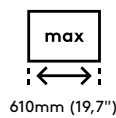
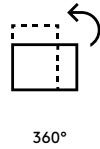
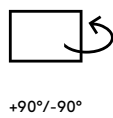
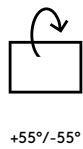
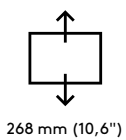
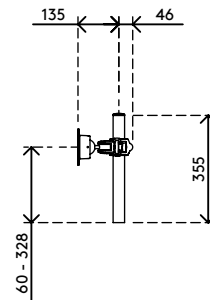
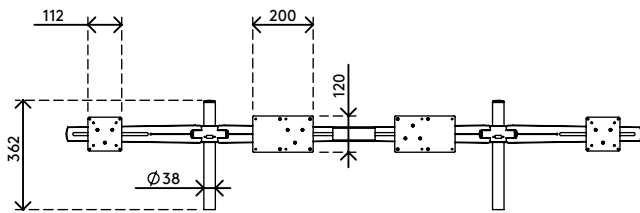
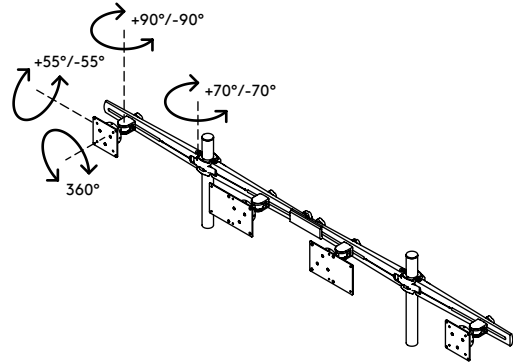
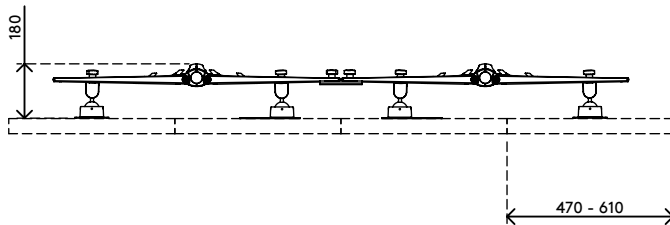

Viewmaster multi-monitor system - desk 443

2015/10/05

53.443

 740 x 395 x 122 mm

 1 pcs

 black

 12,276 kg

 805410534431