

53.223

Viewmaster multi-monitor system - desk 223

This model mounts 2 monitors. Like on all other winged multi-monitor systems, each monitor can be adjusted individually. Cable management in the wings tidies up all cables, resulting in an impressive set-up that can be either flat or curved.

- Stepless height adjustment
- For 2 monitors
- Cable clips and loop ties included
- Die-cast aluminium parts
- VESA MIS-D 75 x 75/100 x 100 mm compatible
- Rotate 360°, tilt +55°/-55°, pivot +90°/-90°
- Weight capacity max. 12 kg per monitor
- Desk mount not included
- Monitor size limit: width 880 - height 618 mm
- Due to excellent stability also suitable for touchscreens

viewmaster x

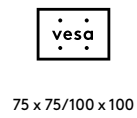
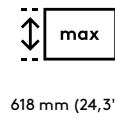
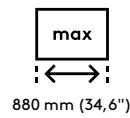
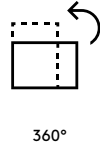
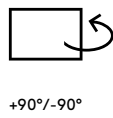
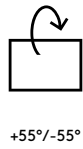
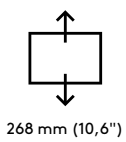
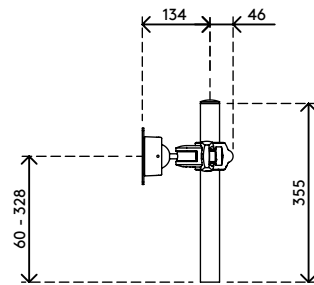
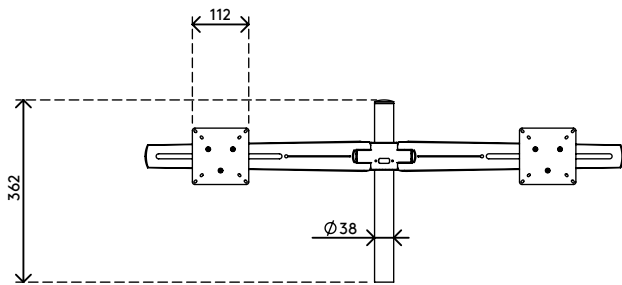
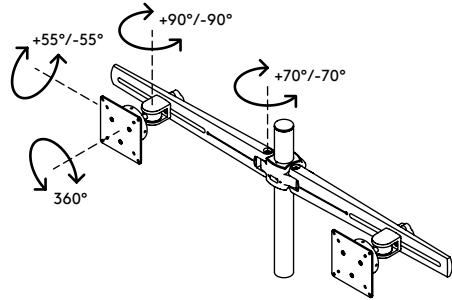
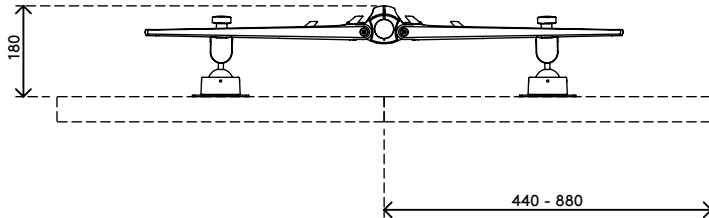

Viewmaster multi-monitor system - desk 223

2015/10/05

53.223

 535 x 250 x 155 mm

 1 pcs

 black

 4,928 kg

 805410532239