

viewlite ^x

5

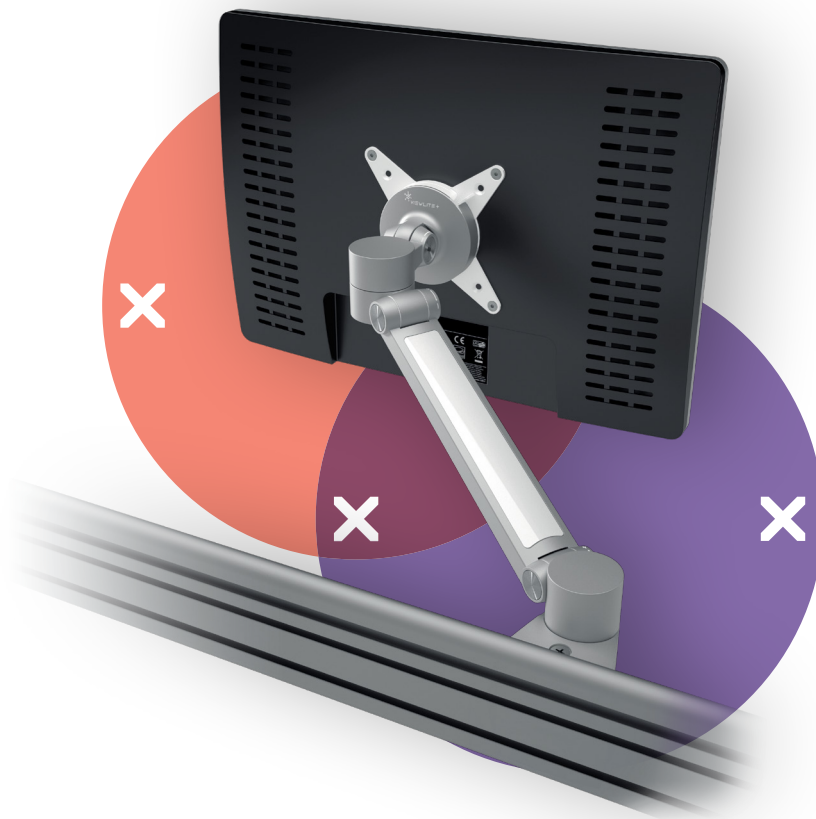

58.512

Viewlite plus monitor arm - rail 512

Free up desk space with this monitor arm that mounts onto a slat rail/wall or toolbar. It's easy to use and with the swivel limiter, which reduces the chance of bumping into walls or desks, you can locate it pretty well anywhere. Cables are easily hidden in the arm's aluminium extension to create a tidy, professional impression.

- Dynamic height adjustment range of 240 mm
- Dependent depth adjustment
- Integrated cable management
- Main components made of aluminium
- 40% of aluminium content is already recycled
- VESA MIS-D 75 x 75/100 x 100 mm compatible
- Rotate 360°, tilt +90°/-55°, swivel +90°/-90°
- Weight capacity min. 0 kg - max. 7 kg per monitor
- Comes with a rail mount
- Fitted with a practical quick-release VESA system
- Monitor rotation lock can be enabled
- Swivel limiter pre-set to +90°/-90° or can be disabled

dataflex

feeling at work

viewlite X

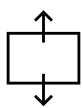
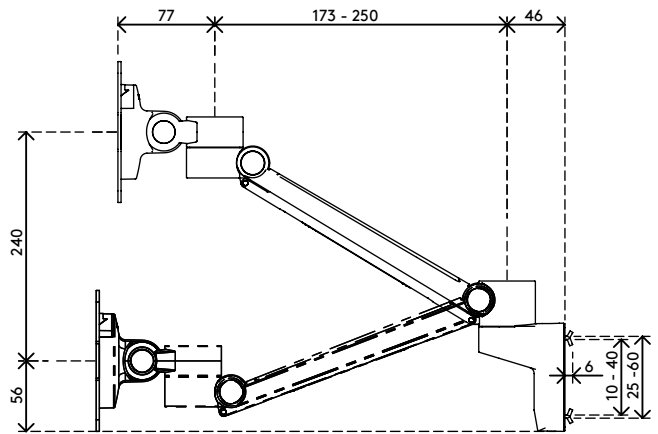
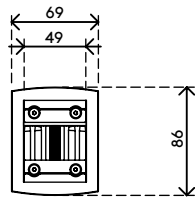
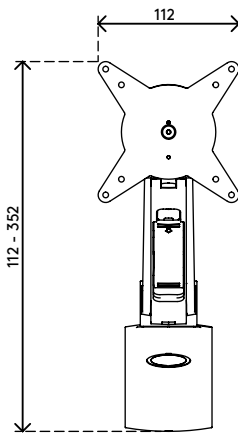
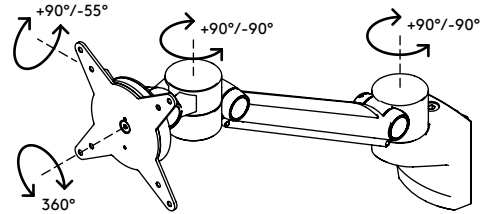
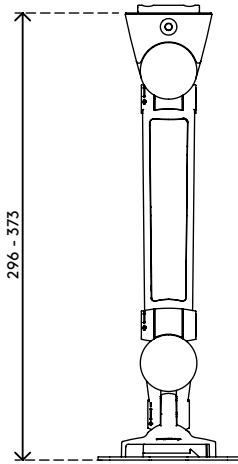

240 mm (9,4")



+90°/-55°

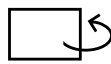

+90°/-90°



360°



75 x 75/100 x 100



0 - 7 kg

Viewlite plus monitor arm - rail 512

2015/10/05

58.512

477 x 153 x 145 mm

1 pcs

silver-white

2,151 kg

805410585129